



## AU CHAU'S PRODUCTS.



## SPIRAL DUCTS & FITTINGS

---

**AU CHAU CO. LTD.**  
**249 To Hien Thanh Street, Dist.10, HCMC, Vietnam**  
**Tel: 84 8 8632 185 – Fax: 84 8 8632184**  
**Website: [www.actec.com.vn](http://www.actec.com.vn)**

## **CONTENT.**

<b>1/ SPIRAL DUCT.</b>	<b>Page 3</b>
<b>2/ ELBOW 90<sup>0</sup>.</b>	<b>Page 4</b>
<b>3/ TEE.</b>	<b>Page 5-6-7</b>
<b>4/ REDUCER.</b>	<b>Page 8-9-10</b>
<b>5/ COUPLING.</b>	<b>Page 11</b>
<b>6/ REC-TO-ROUND TRANSITION.</b>	<b>Page 12</b>
<b>7/ ROUND SILENCER.</b>	<b>Page 13</b>
<b>8/CURVED SILENCER.</b>	<b>Page 14</b>
<b>9/ OTHER PRODUCTS.</b>	<b>Page 15-16</b>
<b>10/ EQUIPMENTS AND MACHINERIES.</b>	<b>Page 17</b>



**2/ ELBOW 90°: R = 1.0D**

**Order code: ELB-250-90**

(Product code-Dimension  $\Phi d$ -Angle  $\alpha$ )

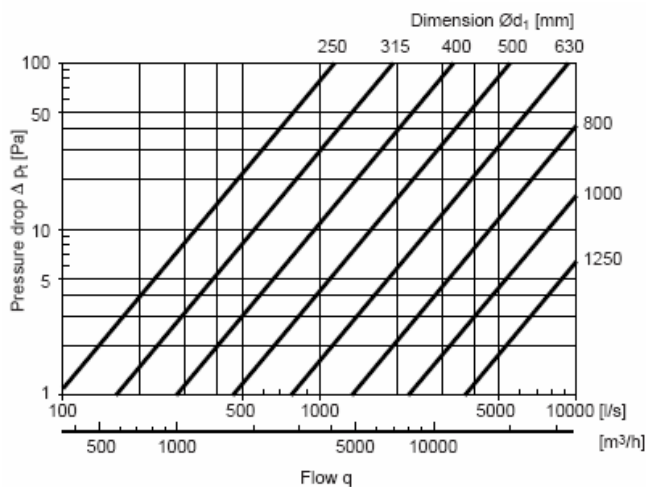
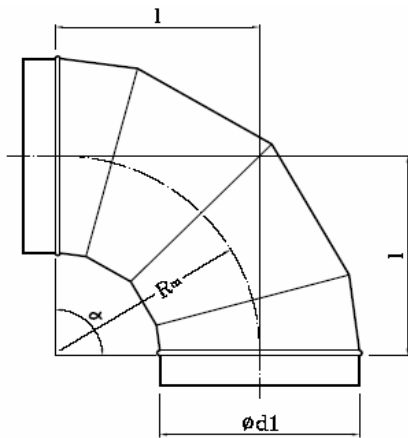

**TECHNICAL DATA**

<b><math>\Phi d</math> (mm)</b>	<b>l (mm)</b>	<b>Tolerances range (mm)</b>
80	105	78.8 - 79.3
100	100	98.8 - 99.3
125	125	123.8 - 124.8
150	150	148.7 - 149.3
175	175	173.7 - 174.3
200	200	198.6 - 199.3
225	225	223.5 - 224.3
250	250	248.5 - 249.3
275	275	273.4 - 274.3
300	300	298.4 - 299.3
350	350	348.3 - 349.3
400	400	398.3 - 399.3
450	450	448.2 - 449.3
500	500	498.2 - 499.3
550	550	548.1 - 549.3
600	600	598.1 - 599.3
650	650	648.1 - 849.3
700	700	698.0 - 699.3
750	750	748.0 - 749.3
800	800	798.0 - 799.3
900	900	897.9 - 899.3
1000	1000	997.9 - 999.3
1100	1100	1097.8 - 1099.3
1200	1200	1197.8 - 1199.3
1300	1300	1297.8 - 1299.3

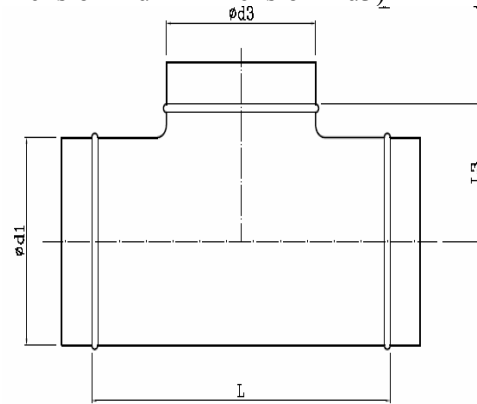
**3/ TEE:****Order code: TEE-250-200** (Product code- Dimension  $\Phi d1$ - Dimension  $\Phi d3$ )

$\Phi d_1$ (mm)	$\Phi d_3$ (mm)	l (mm)	$l_3$ (mm)
80	80	140	52
100	80	103	65
100	100	130	65
125	80	146	75
125	100	130	78
125	125	165	83
150	80	140	87
150	100	175	90
150	125	215	95
150	150	260	95
175	80	140	102
175	100	175	105
175	125	215	110
175	150	260	110
175	175	285	115
200	80	140	112
200	100	175	115
200	125	215	115
200	150	260	120
200	175	285	125
200	200	249	125
250	80	156	137
250	100	175	140
250	125	220	145
250	150	255	145
250	175	306	150
250	200	306	150
250	250	296	150
300	80	156	162
300	100	175	165
300	125	220	170
300	150	255	170
300	175	306	175

$\Phi d_1$ (mm)	$\Phi d_3$ (mm)	l (mm)	$l_3$ (mm)
300	200	306	175
300	250	350	175
300	300	430	175
350	100	175	193
350	125	220	198
350	150	255	198
350	175	306	203
350	200	306	203
350	250	350	203
350	300	430	203
350	350	470	203
400	100	175	215
400	125	225	220
400	150	225	220
400	175	266	225
400	200	300	225
400	250	350	225
400	300	430	225
400	350	470	225
400	400	510	225
450	100	175	240
450	125	225	245
450	150	266	250
450	175	266	250
450	200	300	250
450	250	350	250
450	300	430	250
450	350	470	250
450	400	510	250
450	450	550	225
500	100	175	265
500	125	225	270
500	150	266	275

$\Phi d_1$ (mm)	$\Phi d_3$ (mm)	l (mm)	$l_3$ (mm)
500	200	300	275
500	250	350	275
500	300	430	275
500	350	470	275
500	400	510	275
500	450	550	250
500	500	552	290
550	100	175	295
550	125	225	300
550	150	266	305
550	175	266	305
550	200	300	305
550	250	350	305
550	300	430	280
550	350	470	305
550	400	510	305
550	450	550	280
550	500	552	280
550	550	610	280
600	100	175	315
600	125	225	320
600	150	266	325
600	175	266	325
600	200	300	325
600	250	350	325
600	300	430	300
600	350	470	300
600	400	510	325
600	450	550	300
600	500	552	300
600	550	610	300
600	600	650	300

## Technical data

### Supply air

Diverging flow

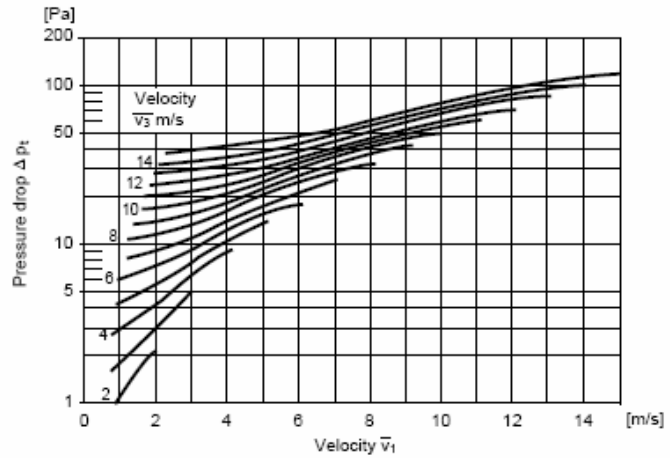
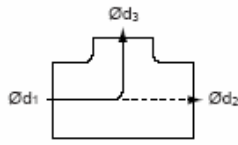

Diverging flow

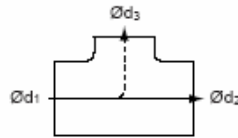

The diagram is also applicable to reduction in  $\varnothing d_2$ .

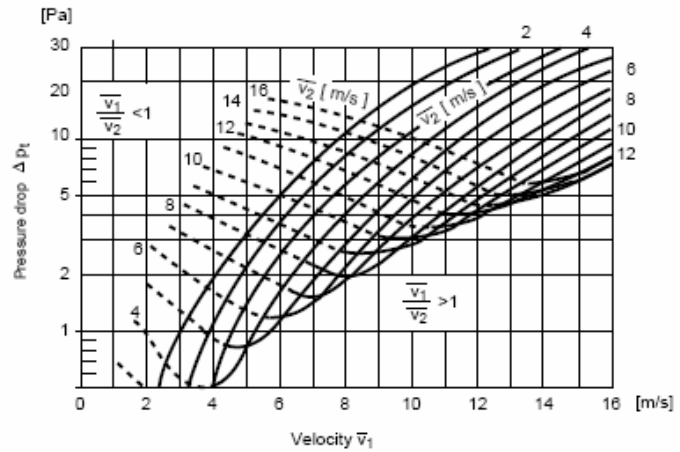

Diverging flow

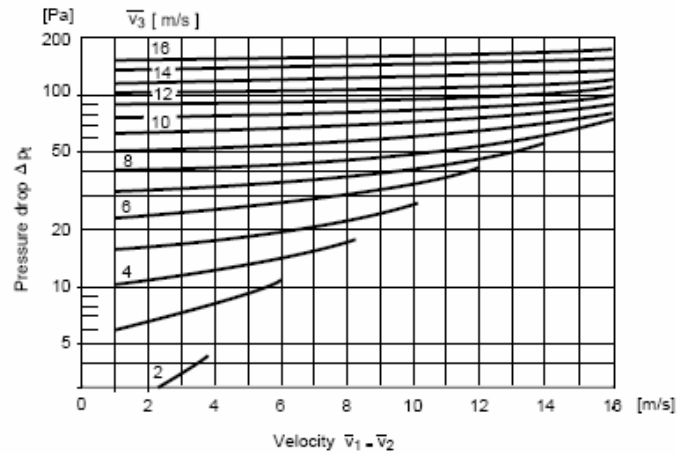
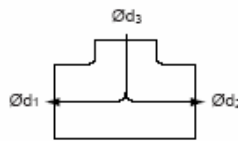

# Technical data

## Exhaust air

Converging flow

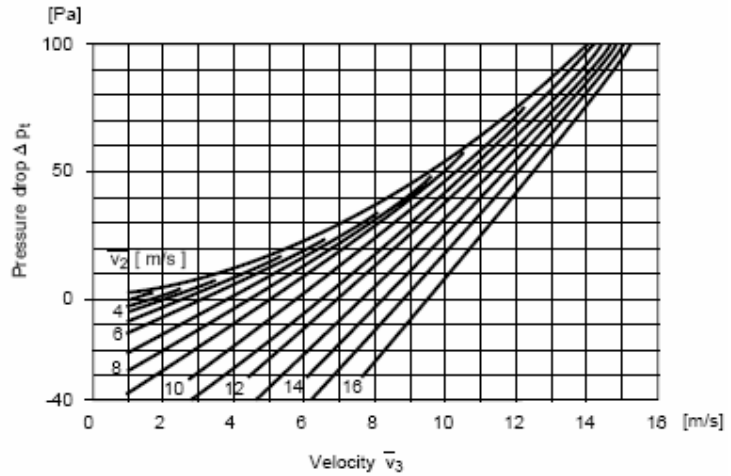
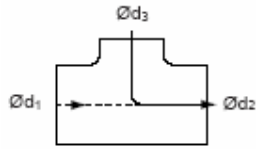

Converging flow

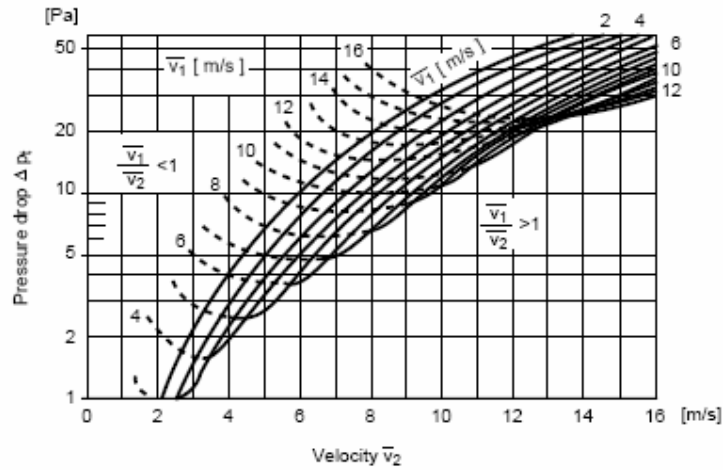
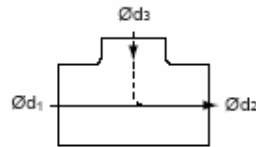

The diagram is also applicable to reduction in Ød1.

Converging flow

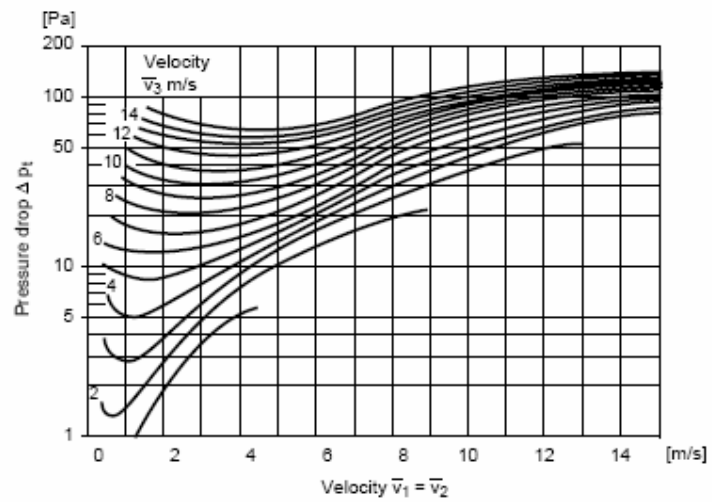
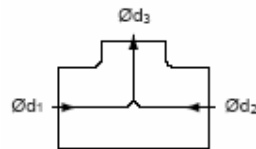

AU CHAU CO. LTD.

249 To Hien Thanh Street, Dist.10, HCMC, Vietnam

Tel: 84 8 8632 185 – Fax: 84 8 8632184

Website: www.actec.com.vn

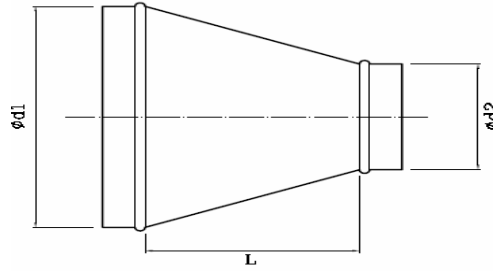
**4/ REDUCER:****Order code: RCLU-200-150** (Product code- Dimension  $\Phi d1$ - Dimension  $\Phi d2$ )

$\Phi d_1$ (mm)	$\Phi d_2$ (mm)	L (mm)
100	80	58
125	80	92
125	100	64
150	80	126
150	100	99
150	125	64
175	80	167
175	100	140
175	125	106
175	150	71
200	80	195
200	100	167
200	125	133
200	150	99
200	175	58
250	100	236
250	125	202
250	150	167
250	175	126
250	200	99
300	125	270
300	150	236
300	175	195
300	200	167
300	250	99
350	150	298
350	175	270
350	200	243
350	250	174
350	300	106
400	150	365
400	175	337
400	200	310
400	250	241
400	300	172
400	350	97

$\Phi d_1$ (mm)	$\Phi d_2$ (mm)	L (mm)
450	200	346
450	250	310
450	300	241
450	350	166
450	400	109
500	200	447
500	250	378
500	300	310
500	350	234
500	400	177
500	450	109
550	300	392
550	350	317
550	400	260
550	450	191
550	500	122
600	250	516
600	300	447
600	350	372
600	400	315
600	450	246
600	500	177
600	550	95
650	250	557
650	300	488
650	350	413
650	400	356
650	450	287
650	500	219
650	550	136
650	600	81
700	350	528
700	400	471
700	450	402
700	500	333
700	550	251

$\Phi d_1$ (mm)	$\Phi d_2$ (mm)	L (mm)
700	600	196
700	650	155
800	400	594
800	450	526
800	500	457
800	550	375
800	600	320
800	630	279
900	450	663
900	500	594
900	550	512
900	600	457
900	630	416
900	700	311
900	800	187
1000	500	732
1000	550	649
1000	600	594
1000	630	553
1000	700	448
1000	800	325
1000	900	187
1100	550	814
1100	600	759
1100	630	718
1100	700	613
1100	800	490
1100	900	352
1100	1000	215
1250	600	938
1250	630	897
1250	700	792
1250	800	668
1250	900	531
1250	1000	393
1250	1100	229

**AU CHAU CO. LTD.**

249 To Hien Thanh Street, Dist.10, HCMC, Vietnam

Tel: 84 8 8632 185 – Fax: 84 8 8632184

Website: www.actec.com.vn



## Technical data

### RCLU

#### 1 step reduction

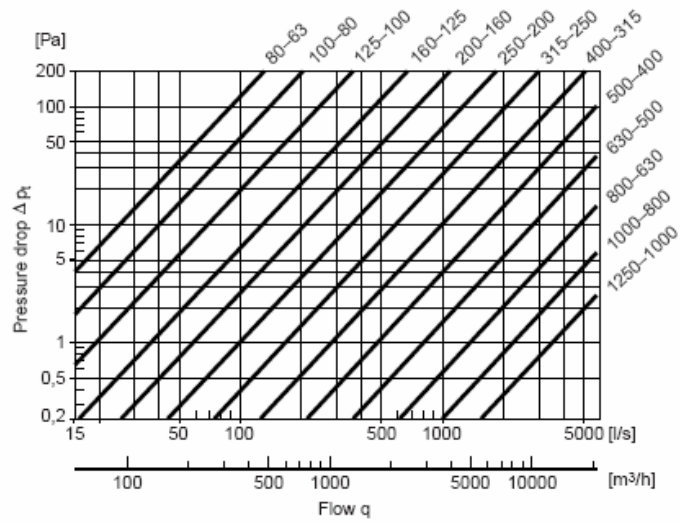
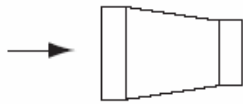

### RCLU

#### 2 steps reduction

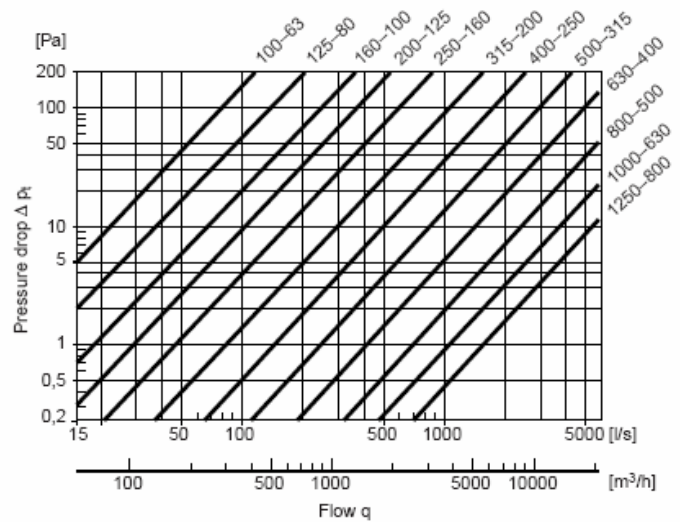
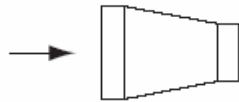

### RCLU

#### 3 steps reduction

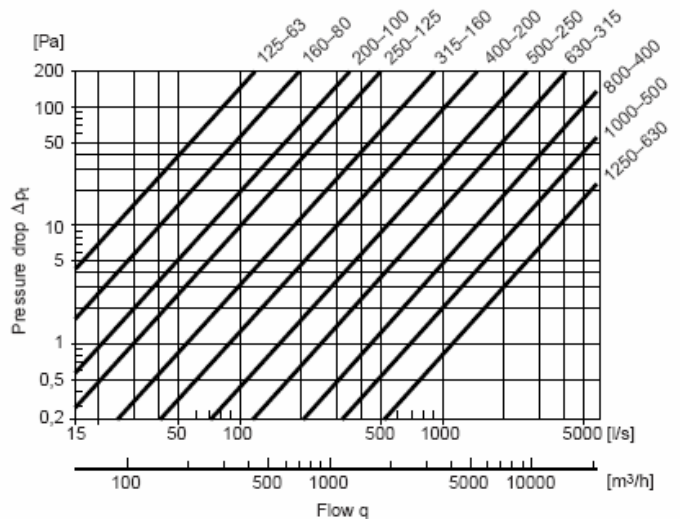
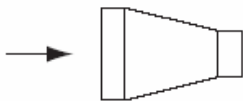

# Technical data

## RCLU 1 step reduction

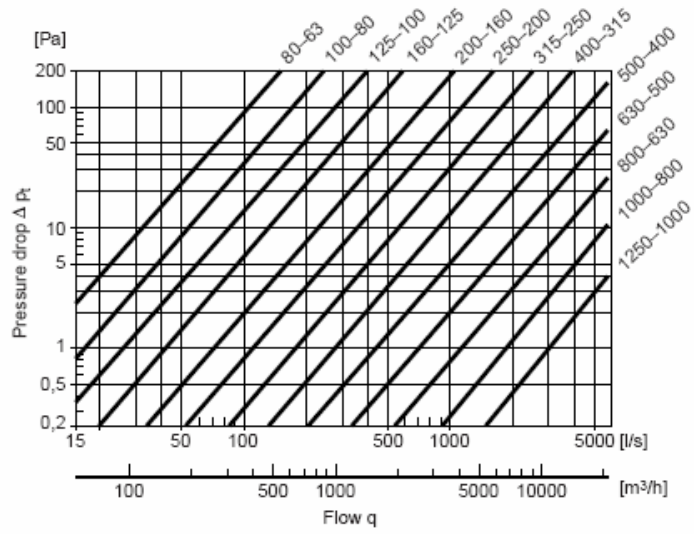
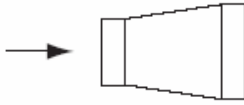

## RCLU 2 steps reduction

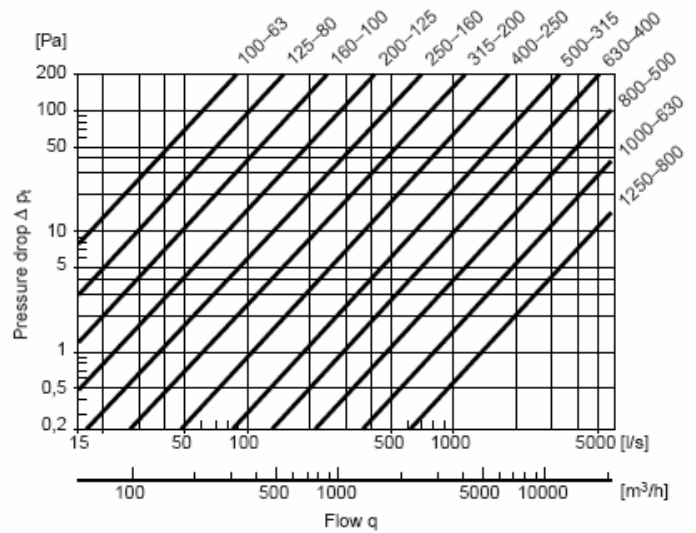
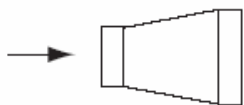

## RCLU 3 steps reduction

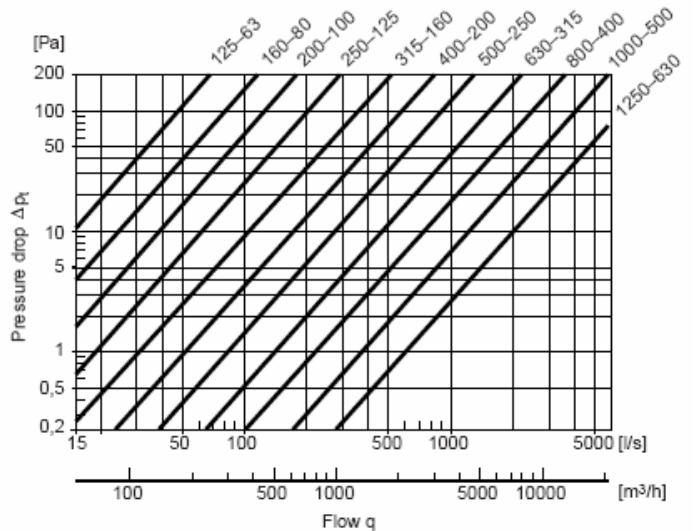
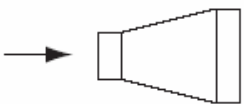

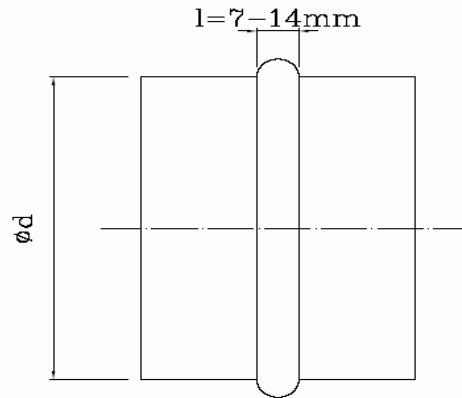
**5/ COUPLING:****Order code: COUP-200** (Product code- Dimension  $\Phi d_1$ )

$\Phi d_1$ (mm)
80
100
125
150
175
200
225
250
275
300
350
400
450

$\Phi d_1$ (mm)
500
550
600
650
700
750
800
900
1000
1100
1200
1300

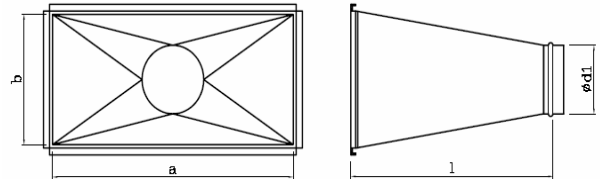
**6/ REC-TO-ROUND TRANSITION:****Order code: RTR-500-300-150** (Product code- Width a- Height b-Dimension  $\Phi d_1$ )

<b>a (mm)</b>	<b>L (mm)</b>
100	300
125	300
150	300
175	300
200	300
225	300
250	300
275	300
300	300
350	300
400	450
450	450

<b>a (mm)</b>	<b>L (mm)</b>
500	450
550	450
600	450
650	450
700	450
750	600
800	600
900	600
1000	600
1100	600
1200	600
1300	600

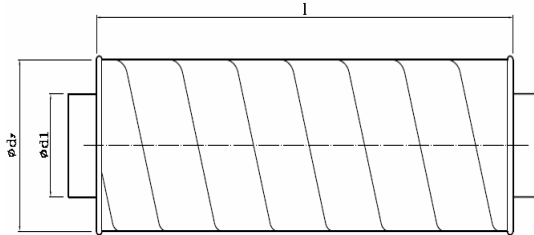
**7/ ROUND SILENCER:****Order code: SLC-150-300-50** (Product code- Dimension  $\Phi d_1$ -Length l- insulation thickness)

Attenuation in dB for centre frequency										
$\Phi d_1$	l	Hz								$\Phi d_2$
(mm)	(mm)	63	125	250	500	1k	2k	4k	8k	(mm)
80	300	2	4	8	16	27	34	35	19	190
80	600	3	9	16	28	46	53	46	25	190
80	900	4	5	20	36	56	57	58	41	190
80	1200	5	6	23	40	62	61	62	45	190
100	300	3	4	8	14	23	27	25	14	210
100	600	3	8	13	25	40	50	40	21	210
100	900	3	5	18	33	53	55	48	28	210
100	1200	3	6	22	39	60	61	53	33	210
125	300	3	2	7	14	21	26	20	12	235
125	600	2	7	12	23	39	47	32	18	235
125	900	0	3	16	29	53	52	39	24	235
125	1200	0	3	18	37	60	59	52	28	235
160	300	3	2	5	12	17	24	17	11	270
160	600	3	4	8	21	37	40	22	14	270
160	900	0	4	12	27	46	51	29	20	270
160	1200	0	3	14	34	51	53	33	18	270
200	300	3	1	4	10	16	20	14	11	310
200	600	2	4	8	20	31	32	20	15	310
200	900	0	4	10	25	32	40	24	18	310
200	1200	0	4	13	32	51	48	28	17	310
250	600	1	2	6	15	27	25	15	14	365
250	900	0	2	8	22	37	34	18	16	365
250	1200	0	2	10	27	42	39	20	18	365
315	600	3	3	7	12	17	14	11	10	465
315	900	1	3	9	17	25	20	14	13	465
315	1200	2	3	12	24	37	23	17	15	465

**AU CHAU CO. LTD.**

249 To Hien Thanh Street, Dist.10, HCMC, Vietnam

Tel: 84 8 8632 185 – Fax: 84 8 8632184

Website: www.actec.com.vn

## Technical data

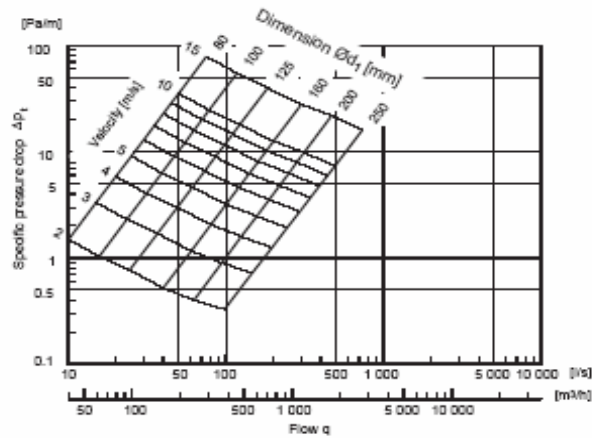

### 8/ CURVED SILENCER:

**Order code:** CSLC-200-100 (Product code- Dimension Φd1- insulation thickness)

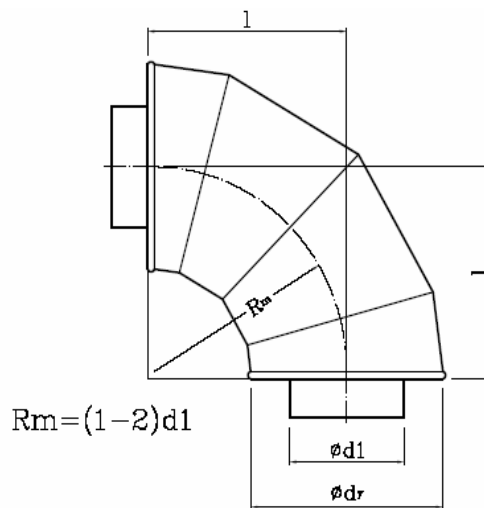

Attenuation in dB for centre frequency										
Φd <sub>1</sub>	l	Hz								Φd <sub>v</sub>
(mm)	(mm)	63	125	250	500	1k	2k	4k	8k	(mm)
125	260	4	2	13	22	25	35	39	33	325
160	280	4	7	14	18	26	38	33	25	365
200	325	5	6	15	22	29	34	32	27	410
250	370	2	4	11	16	27	28	26	22	465
315	375	1	4	11	15	18	17	15	14	510
400	420	1	5	9	14	14	15	14	12	615
500	510	1	5	13	19	14	13	12	10	735
630	610	2	6	14	17	13	12	12	11	880

**AU CHAU CO. LTD.**

249 To Hien Thanh Street, Dist.10, HCMC, Vietnam

Tel: 84 8 8632 185 – Fax: 84 8 8632184

Website: www.actec.com.vn

**9/ OTHER PRODUCTS:**



**\* EXTRACTION HOOD**



**\* REC-TO-ROUND ELBOW 90<sup>0</sup>**



**\* OFFSET REDUCING ELBOW**





\* FLEXIBLE DUCT



\* RECTANGULAR DUCT:



\* VENTILATION HOOD



**EQUIPMENT & MACHINERIES:**

1/ **Tubeformer Anpha 6:** to make spiral ducts machine of diameter 80mm to 1,300mm and thickness 0.6mm to 1.0mm.

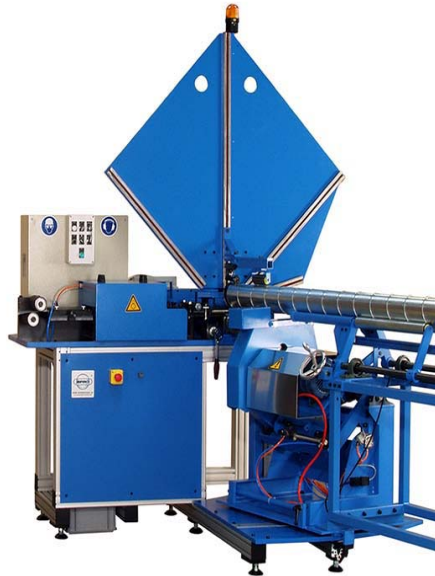

2/ **Plasmacutter Florett:** controlled by CNC program to cut the metal sheet



3/ **Gorelocker Beta 3:** to make the fittings



4/ **Stitchwelder 1000:**

